

REVISIONS			
REV.	DESCRIPTION	DATE	APPROVED
REL-01		7/10/2007	

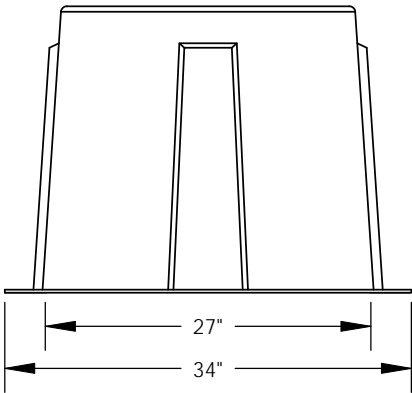
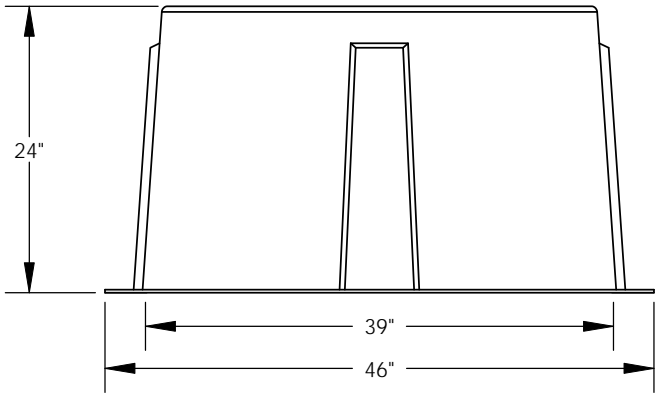
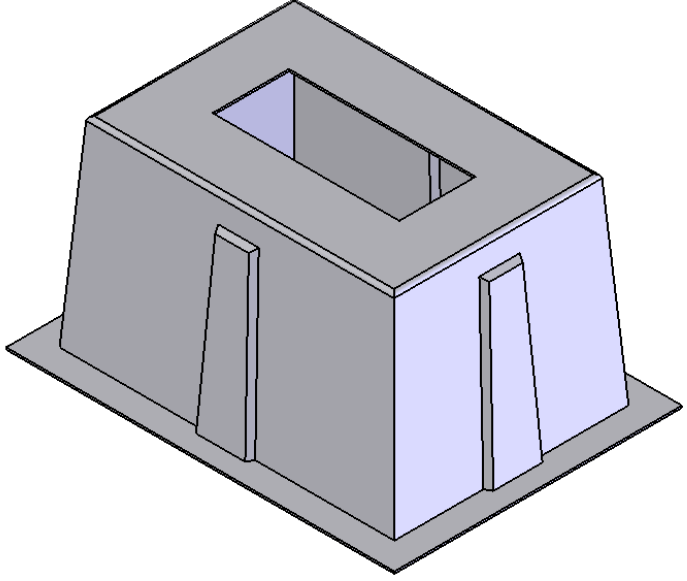
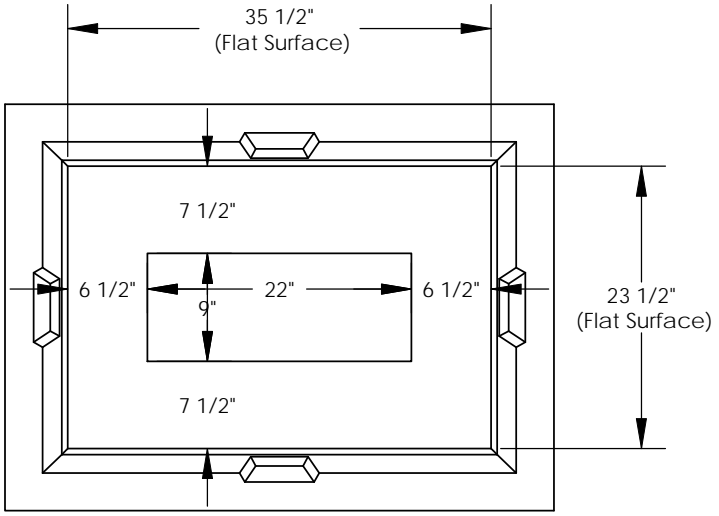

PROPRIETARY AND CONFIDENTIAL
 THE INFORMATION CONTAINED IN THIS DRAWING IS THE SOLE PROPERTY OF NORDIC FIBERGLASS, INC. ANY REPRODUCTION IN PART OR AS A WHOLE WITHOUT THE WRITTEN PERMISSION OF NORDIC FIBERGLASS, INC. IS PROHIBITED.

Customer Name: N/A		
DIMENSIONS ARE IN INCHES		
TOLERANCES: ANGLES $\pm 1^\circ$		
FRACTIONAL $\pm 1/2$		
ONE PLACE DECIMAL $\pm .060$		
TWO PLACE DECIMAL $\pm .030$		
THREE PLACE DECIMAL $\pm .015$		
MATERIAL		
DRAWN	NAME	DATE
	P.J.W.	07/10/07
CHECKED	---	--/--

Nordic Fiberglass, Inc.
 21415 US Hwy 75 NW, Warren, MN 56762
 www.nordicfiberglass.com
 218-745-5095 ph. --- 218-745-4990 fax

GST-36-24-24-GR-22x9

SIZE	ITEM ID:	REV.
A	02340.00	REL-01
SCALE: 1:16	SHEET 1 OF 1	